

**08** **Volt- and ammeter switches**  
**Position indicators**



## VOLT- AND AMMETER SWITCHES

**V - Serie**

page 8/1

**AU - Serie**

page 8/2

**TP - Serie**

page 8/3

## POSITION INDICATORS

**PI / PIR**

page 8/4

Electronic Position Indicators on request.

# VOLT- AND AMMETER SWITCHES / POSITION INDICATORS

## Voltmeter- and ammeter switches:

Voltmeter- and ammeter switches are applied to select the AC-phases to be measured. This way, one single instrument can be used for measurement of current or voltage of different phases, respectively phase-to-phase and phase-to-zero. Some types additionally have a zero-position. Switches are available for panel-mounting or DIN-rail mounting. Panel-mounting-types are 4-hole screw-fixing, or one-hole-central-fixing.

## Position indicators:

Position indicators display the actual position of circuit-breakers and isolators. They are designed for mounting in instrument-panels or in Mimic panels. The position indicators are available for AC and DC-voltages and in different formats and sizes.



# VOLTMETER SWITCHES

## Volmete swith V - Serie

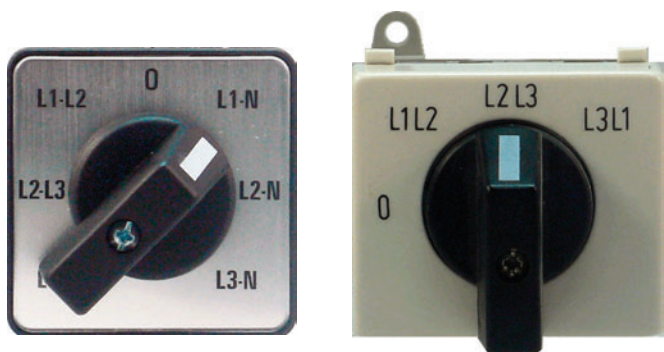

## Voltmeter switches

- One hole - central mounting
- For front panel- or for DIN-rail mounting

### Application

One hole-central mounting, degree of protection IP65, rated current  $I_n = 20A$  (16A for TP-line), rated voltage 690V, frontplate labelled, handle in black color. Switches are completely wired and labelled. Clamps are protected against direct contact according to VDE 0106, chapter 100 and VBG 4 respectively.

Voltmeter switch with 0 position,  
3 phase-to-phase and 3 phases against neutral

Voltmeter switch without 0 position,  
3 phase-to-phase and 3 phases against neutral

V 30 - 8 ZM  
V 30 - 8 T

One hole - central mounting  
Din rail mounting

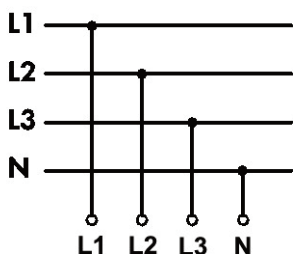
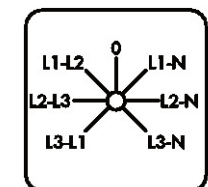

VN 30 - 8 ZM  
VN 30 - 8 T

One hole - central mounting  
Din rail mounting

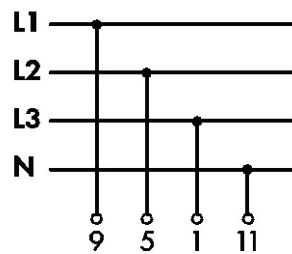
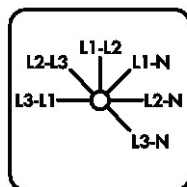

Voltmeter switch with 0 position, 3 phase-to-phase

Voltmeter switch without 0 position, 3 phase-to-phase

V 3 - 8 ZM  
V 3 - 8 T

One hole - central mounting  
Din rail mounting

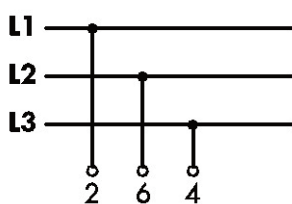
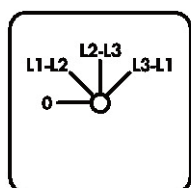

VN 3 - 8 ZM  
VN 3 - 8 T

One hole - central mounting  
Din rail mounting

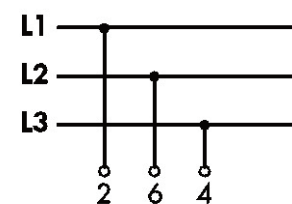
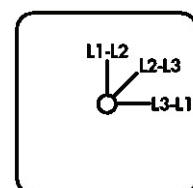

# AMMETER SWITCHES

Voltmeter switch with 0 position, 3 phases to neutral voltages

VO - 8 ZM  
VO - 8 T

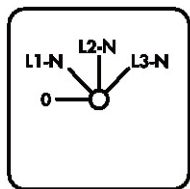

One hole - central mounting  
Din rail mounting

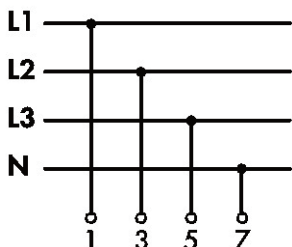

More change-over switches on request.

## V - Serie

Description	Article No.
V 30 - 8 ZM	70061 - 1017
V 30 - 8 T	70061 - 1016
V 3 - 8 ZM	70061 - 1015
V 3 - 8 T	70061 - 1014
VN 30 - 8 ZM	70061 - 1021
VN 30 - 8 T	70061 - 1020
VN 3 - 8 ZM	70061 - 1019
VN 3 - 8 T	70061 - 1042
VO - 8 ZM	70061 - 1013
VO - 8 T	70061 - 1012

## AU - Serie

AU 31 - 8 ZM - X 96	70061 - 1002
AU 31 - 8 T - X 96	70061 - 1043
AU 31 - 8 ZM	70061 - 1001
AU 31 - 8 T	70061 - 1003

## Ammeter switches AU - Serie

Ammeter switch without "0" position, 1 pole, 3 current transformers

Ammeter switch with "0" position, 1 pole, 3 current transformers

AU 31 - 8 ZM - X 96  
AU 31 - 8 T - X 96

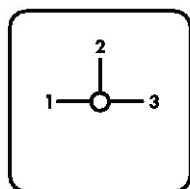

One hole - central mounting  
Din rail mounting

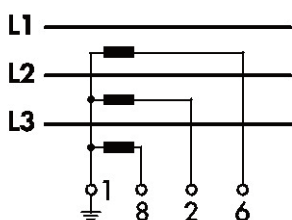

AU 31 - 8 ZM  
AU 31 - 8 T

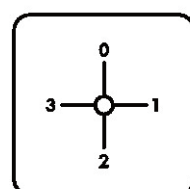

One hole - central mounting  
Din rail mounting

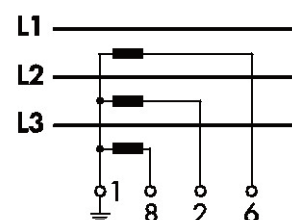

## Dimensions

E	31 mm
D	39 x 41 mm
Type	Length L (in mm)
V 30 - 8 ZM	82
VN 30 - 8 ZM	82
AU 31 - 8 ZM	82
AU 31 - 8 ZM - X 96	82
V 3 - 8 ZM	70
VN 3 - 8 ZM	70
VO - 8 ZM	70
TP - 705	55
TP - 731	55

Central mounting

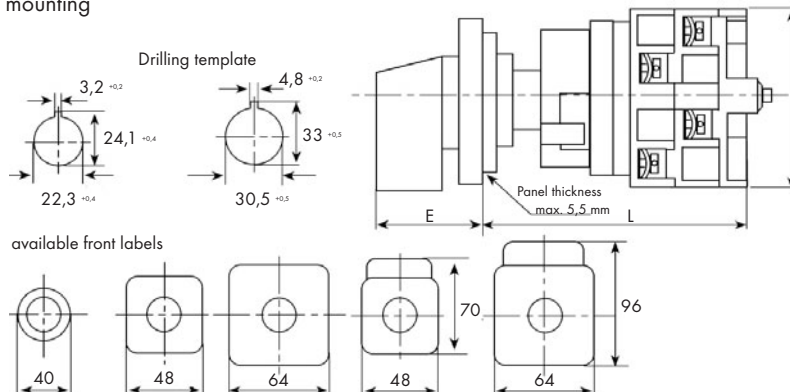

# VOLT- AND AMMETER SWITCHES

## Volt- / Ammeter switches TP - Serie

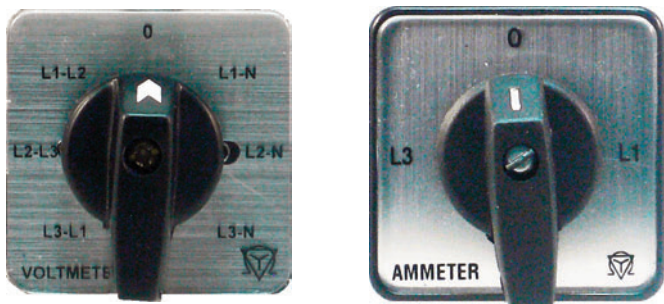

### Volt- and ammeter switches

- Mounting by 4 screws
- For front panel mounting

#### Application

Mounting by 4-hole screw-fixing, degree of protection IP65, rated current  $I_n = 16A$ , rated voltage 690V, frontplate labelled, handle in black color. Switches are completely wired and labelled. Clamps are protected against direct contact according to VDE 0106, chapter 100 and VBG 4 respectively.

#### TP - Serie

Description	Article No.
TP - 705	70097 - 2982
TP - 731	70097 - 2983

Voltmeter switch with "0" position,  
3 phase to phase voltages and 3 phases against neutral

TP-705

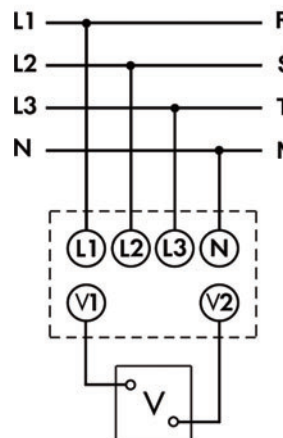
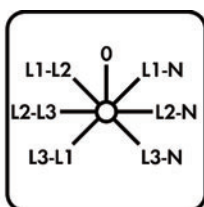

Ammeter switch with "0" position, 1 pole, 3 current transformers

TP-731

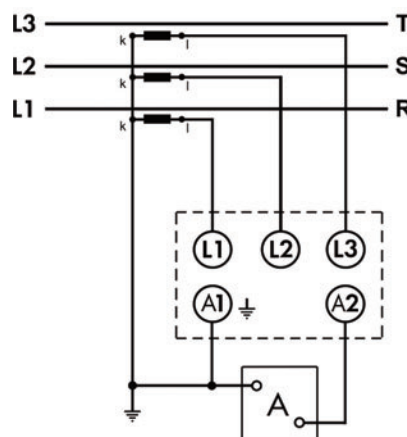
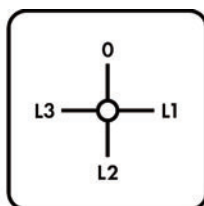

# POSITION INDICATORS

## PI / PIR



### Position Indicators

- Easy mounting
- Wide band voltage inputs
- Independent working position

Electronic position indicators on request

	DC voltages 24 - 230 V					AC voltages 24 - 230 V				
Type	PI 24	PI 25	PI 36	PI 29	PI 39	PIR24	PIR25	PIR36	PIR29	PIR39
Article No. 70063	- 1000	- 1001	- 1003	- 1002	- 1005	- 1006	- 1007	- 1009	- 1008	- 1010
Front frame	□ 24,0	□ 25,0	□ 36,0	∅ 29,0	∅ 39,0	□ 24,0	□ 25,0	□ 36,0	∅ 29,0	∅ 39,0
Housing	∅ 21,8	∅ 21,8	∅ 21,8	∅ 21,8	∅ 21,8	∅ 21,8	∅ 21,8	∅ 21,8	∅ 21,8	∅ 21,8
Installation depth	94	94	94	94	94	94	94	94	94	94
Cut out	∅ 22 <sup>+0,5</sup>	∅ 22 <sup>+0,5</sup>	∅ 22 <sup>+0,5</sup>	∅ 22 <sup>+0,5</sup>	∅ 22 <sup>+0,5</sup>	∅ 22 <sup>+0,5</sup>	∅ 22 <sup>+0,5</sup>	∅ 22 <sup>+0,5</sup>	∅ 22 <sup>+0,5</sup>	∅ 22 <sup>+0,5</sup>
Front panel thickness	0... 12	0... 12	0... 12	0... 12	0... 12	0... 12	0... 12	0... 12	0... 12	0... 12
Weight approx.	0,1 kg	0,1 kg	0,15 kg	0,12 kg	0,12 kg	0,1 kg	0,1 kg	0,15 kg	0,12 kg	0,12 kg

Mounting dimension in mm. Options: spacer 121 702 for mimic panels, 24 - 36 mm.

### Electrical features

Position indicators for AC and DC voltages between 24 - 90 V and 91 - 230 V available.

PI	Connect to DC voltages
PIR	Connect to AC voltages
Consumption	0,4 W at 110 V 1,4 W at 230 V
Prüfspannung	3,7 kV

### Norms

Our position indicators are manufacture according the following standards: IEC51, EN50081-1, EN50082-1, EN50081-2, EN50082-2, IEC 473

Persons safety	EN 61010-1 Category III, table D12, double insulation
Voltage range	max. 300 V

### Mechanical Features

Design	Round plastic case with round or square front frame for panel mounting (PI/PIR 25/29/36) or mimic panels (PI/PIR 24)
Housing material	Polycarbonat UL 94 VO
Front frame	Plastic
Front frame color	Black
Working position	Independent
Mounting	Connecting nut
Connecting clamps	Screw clamps till 1,5 mm <sup>2</sup> with terminal cover
Protection	IP54

### Connecting diagrams:

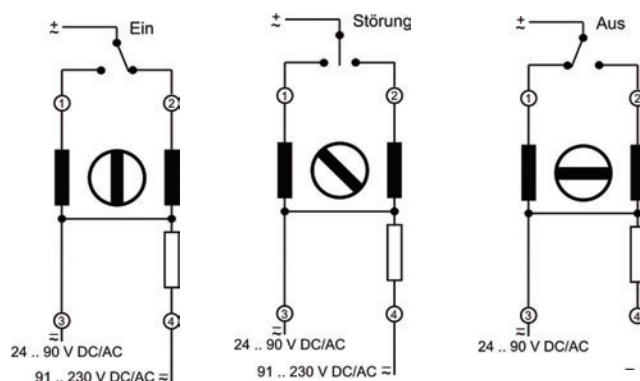

### Dimensions:

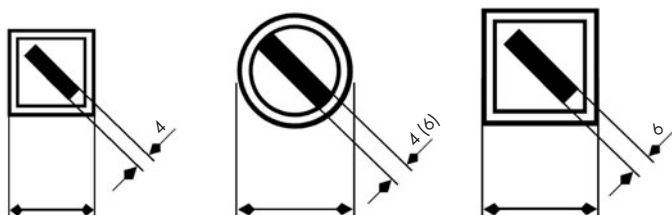
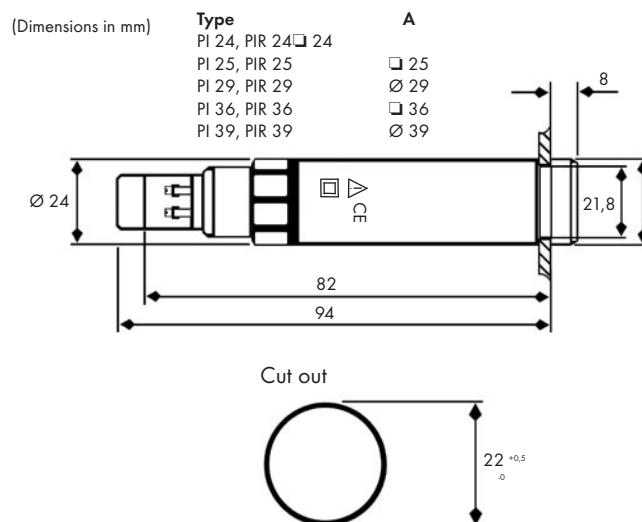





**Celsa Messgeräte GmbH**  
**Barthelsmühlring 16**  
**D - 76870 Kandel**  
**Deutschland**  
**Tel: + 49 (0) 7275 / 9883-0**  
**Fax: + 49 (0) 7275 / 9883-33**  
**[www.celsagermany.com](http://www.celsagermany.com)**  
**[info@celsagermany.com](mailto:info@celsagermany.com)**

